

# Achilles EXP II



Affordable and convenient fracture risk assessment using quantitative ultrasound

**Compact design. Portable.  
Reliable. Radiation free.**

Healthy aging. Strong bones. It's vital.

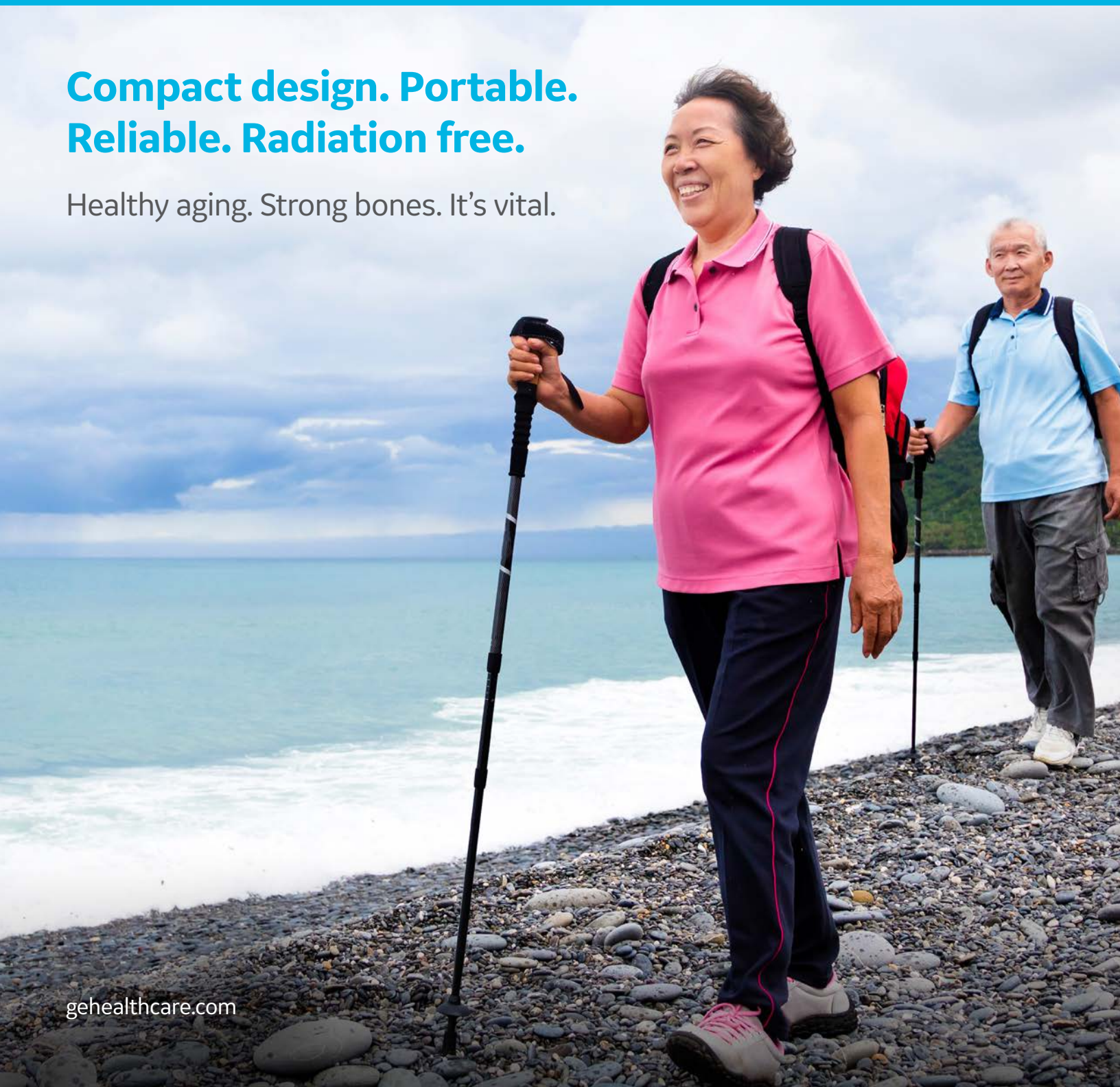

# Osteoporosis

Osteoporosis is a disease of global relevance and affects millions of women worldwide. Osteoporosis is estimated to affect 200 million women worldwide – approximately one-tenth of women aged 60, one-fifth of women aged 70, two-fifths of women aged 80 and two-thirds of women aged 90.

Worldwide, osteoporosis causes more than 8.9 million fractures annually, resulting in an osteoporotic fracture every 3 seconds.<sup>1</sup>

Osteoporosis affects  
**200 million**  
women worldwide.

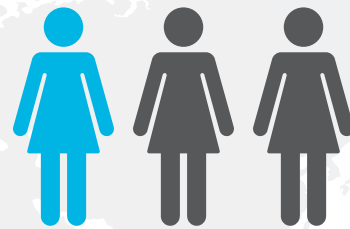

Osteoporosis affects  
**1 in 3** women  
around the world.

## Quick and affordable way for initial osteoporosis assessment

GE Healthcare offers Achilles EXP II – a quick, convenient and affordable product for initial assessment of osteoporosis and fracture risk.

Based on the Quantitative Ultrasound (QUS) technology, Achilles EXP II helps you protect the vitality of your patients by making accurate fracture risk assessment both comfortable and convenient.

Achilles EXP II can be used as an effective initial Osteoporosis assessment tool before proceeding for a DXA scan. The exam is quick and comfortable for your patients, and its user-friendly design makes it easy for your staff to operate, with no formal certification required.

## Osteoporosis fracture risk

Relative risk = 2.0/S.D.

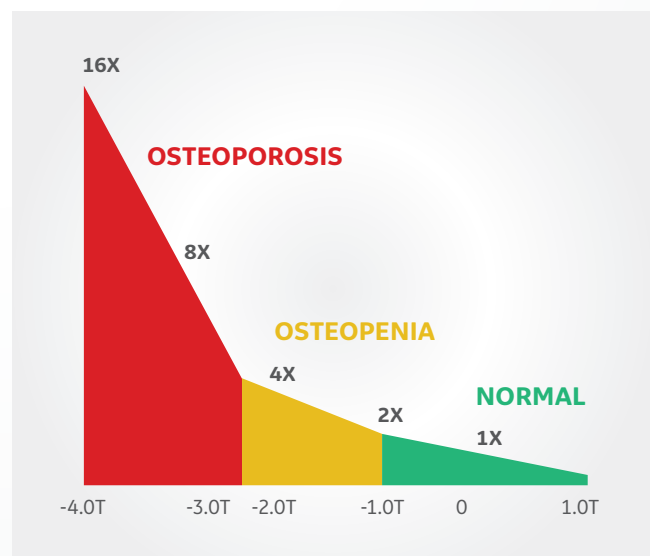



# What is Quantitative Ultrasound (QUS)?

Quantitative Ultrasound (QUS) offers you portable and accurate technology for measuring bone properties at the calcaneus (heel bone) without the use of ionizing radiation. QUS helps you accurately predict fracture risk for post-menopausal women.

QUS technology is based on ultrasound waves that easily pass through fluid and human tissues, and

undergo attenuation based on the density of the calcaneus bone. Analysis of this attenuation can be used to generate empirical measurement.

Quantitative ultrasound can be used to measure a variety of parameters that pertain to bone density by measuring values related to the velocity and attenuation of ultrasound waves as they pass through bone.

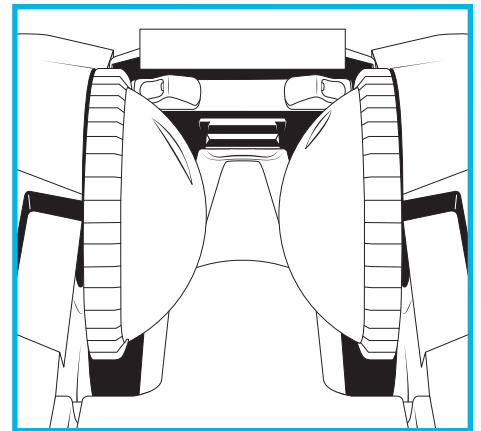
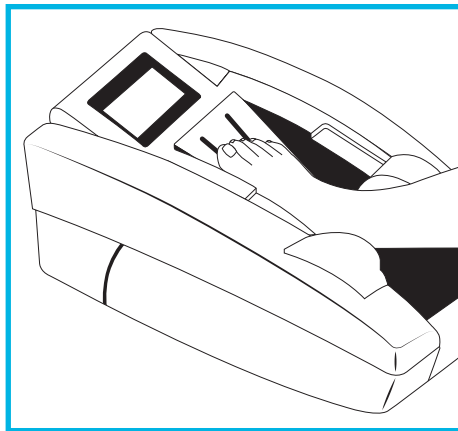

*Awareness and education can lead to strength and vitality.*



# How Achilles EXPII Works

The Achilles EXPII bone ultrasonometers use high frequency sound waves (ultrasound) to evaluate bone status in the heel, the os calcis. Achilles EXPII measurements are performed with the person seated, with one foot placed on the Footplate. The heel is surrounded by warm water encapsulated between inflated membranes. Water is the optimum medium for the transmission of ultrasound. A transducer on one side of the heel converts an electrical signal into a sound wave, which passes through the water and the person's heel. A transducer at a fixed distance on the opposite side of the heel receives the sound wave and converts it to an electrical signal that is analyzed. The Achilles EXPII measure the speed of sound (SOS) and the frequency-dependent attenuation of the sound waves (broadband ultrasound attenuation or BUA), and combines them to form a clinical measure called the **Stiffness Index**.

Ultrasonometry provides a measurement of physical properties of bone. Two of the most commonly used ultrasound measures are the velocity (speed of sound; SOS in m/sec) and frequency attenuation (broadband ultrasound attenuation; BUA in dB/ MHz) of a sound wave as it travels through a bone.<sup>2-6</sup>

The ultrasound characteristics of trabecular bone usually correlate well ( $r > 0.8$ ) with bone density in vitro,<sup>7-19</sup> but the ultrasound characteristics may provide incremental information about bone strength not provided by density alone.

To express the ultrasound results, the Achilles combines the SOS and BUA values to calculate a clinical measure called the **Stiffness Index**.



## Ultrasound transmission

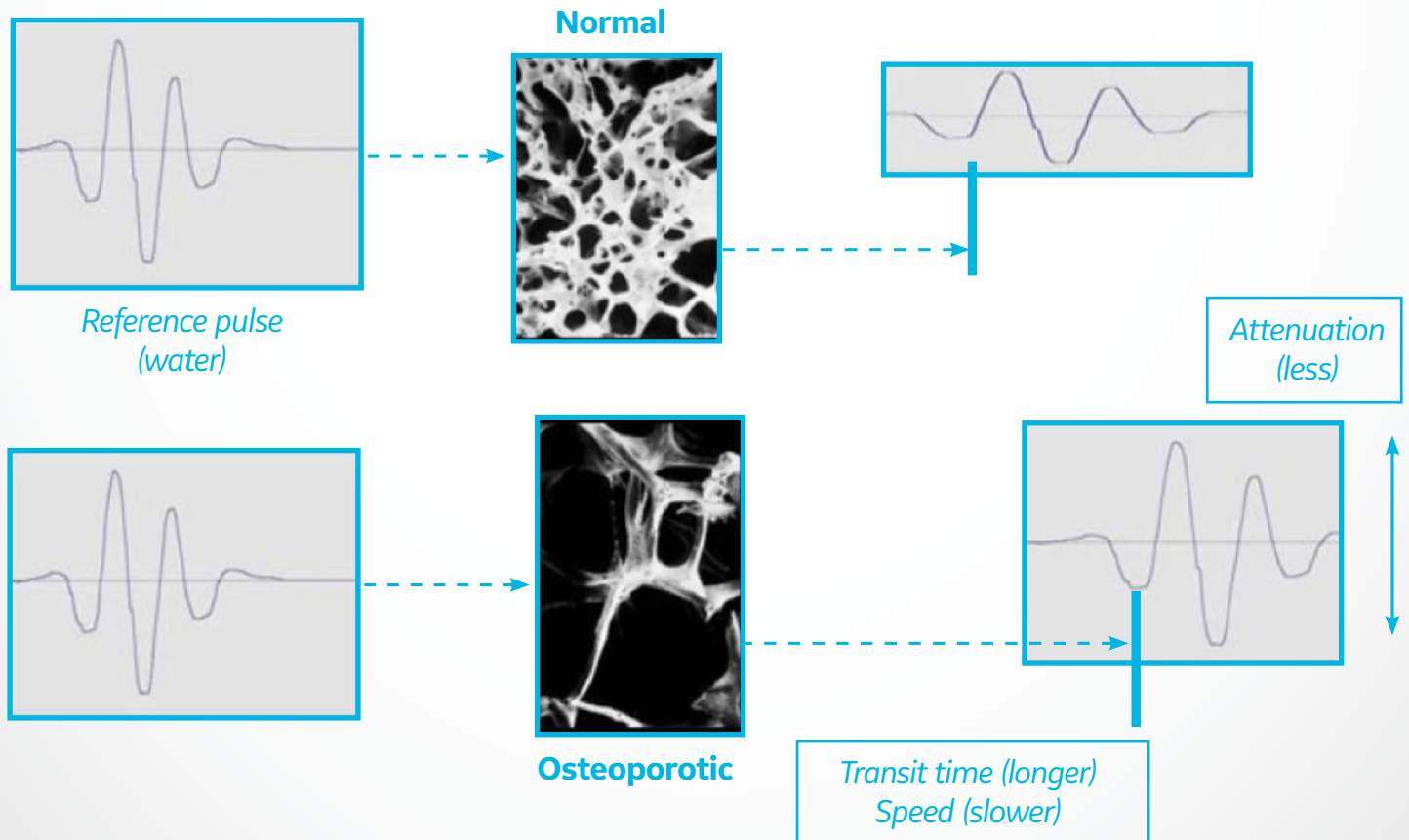

# Stiffness Index

The Achilles ultrasonometer measures ultrasound variables of the os calcis to provide a clinical measure called Stiffness Index – indicating risk of osteoporotic fracture in postmenopausal women comparable to bone mineral density (BMD) as measured by X-ray absorptiometry at the spine or hip.

Stiffness index results expressed as t-scores are used to assist the physicians in the diagnosis of osteoporosis in the same way as are t-scores or obtained by X-ray absorptiometry. Either the stiffness index t-score or X-ray absorptiometry t-score can be utilized by a physician, in conjunction with other clinical risk factors, to provide a comprehensive skeletal assessment.

The stiffness index has a precision error in older women comparable to that of x-ray absorptiometry, which makes it suitable for monitoring bone changes.

The Stiffness Index combines BUA and SOS into a single clinical measure that has a lower precision error than either variable alone. BUA and SOS vary in opposite directions with temperature. The linear combination of BUA and SOS cancel measurement variations as the temperature of the heel and water equilibrate. This provides decreased precision error, and faster measurements.

The Stiffness Index is constructed by “normalizing” BUA and SOS through subtracting the lowest observable values (50 dB/MHz and 1380 m/sec) from each and then scaling the resultant values. The Stiffness Index is the sum of the scaled and normalized BUA and SOS values. The resultant formula is:

$$\text{Stiffness Index} = (0.67 * \text{BUA} + 0.28 * \text{SOS}) - 420.$$

Note that normalized and scaled BUA and SOS values contribute about equally to the resulting Stiffness Index over the adult age range.

	Unadjusted		Normalized and Scaled		
	BUA	SOS	nBUA	nSOS	Stiffness Index = nBUA + nSOS
Age 20	125	1560	50	50	100
Age 60	108	1520	39	39	78
Osteoporotic	95	1485	30	30	60

The International Society for Clinical Densitometry (ISCD)<sup>20</sup> has confirmed that peripheral bone density measurements have value for assessing fracture risk and identifying individuals who should be considered for a DXA measurement. Of the available techniques quantitative ultrasound (QUS) is one of the best methods for assessing fracture risk in men and postmenopausal women.

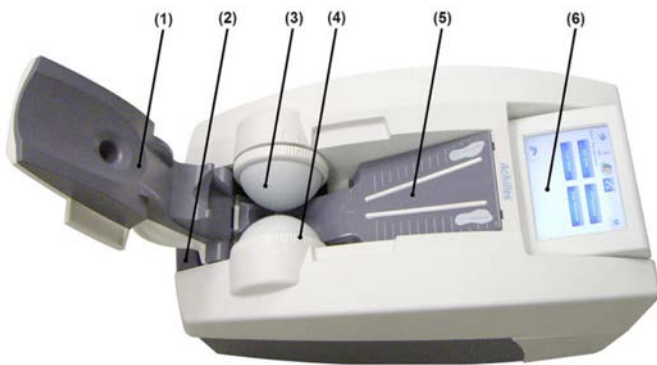

- |  |  |                            |
|--|--|----------------------------|
| (1) Calf Support                       | (6) LCD Display with Touch Panel                   | (11) Fuse Box              |
| (2) Handle                             | (7) Stylus, for Touch Panel                        | (12) Power Switch          |
| (3) (Inflated) Membrane (applied part) | (8) USB-Host (Thumb Drive, External Printer)       | (13) Power Cable Jack      |
| (4) Membrane Retainer Ring             | (9) USB-Slave (PC Software Option)                 | (14) Water Management Tray |
| (5) Footplate (applied part)           | (10) Internal Printer Door with Thermal Paper Slot |                            |



# High negative predictive value

QUS technology offers high negative predictive value – 97 percent for 50 to 59-year-old Caucasian women – making Achilles EXPIL especially useful for discriminating between those not at risk for fracture and those in need of further evaluation by central DXA.<sup>20,21</sup>

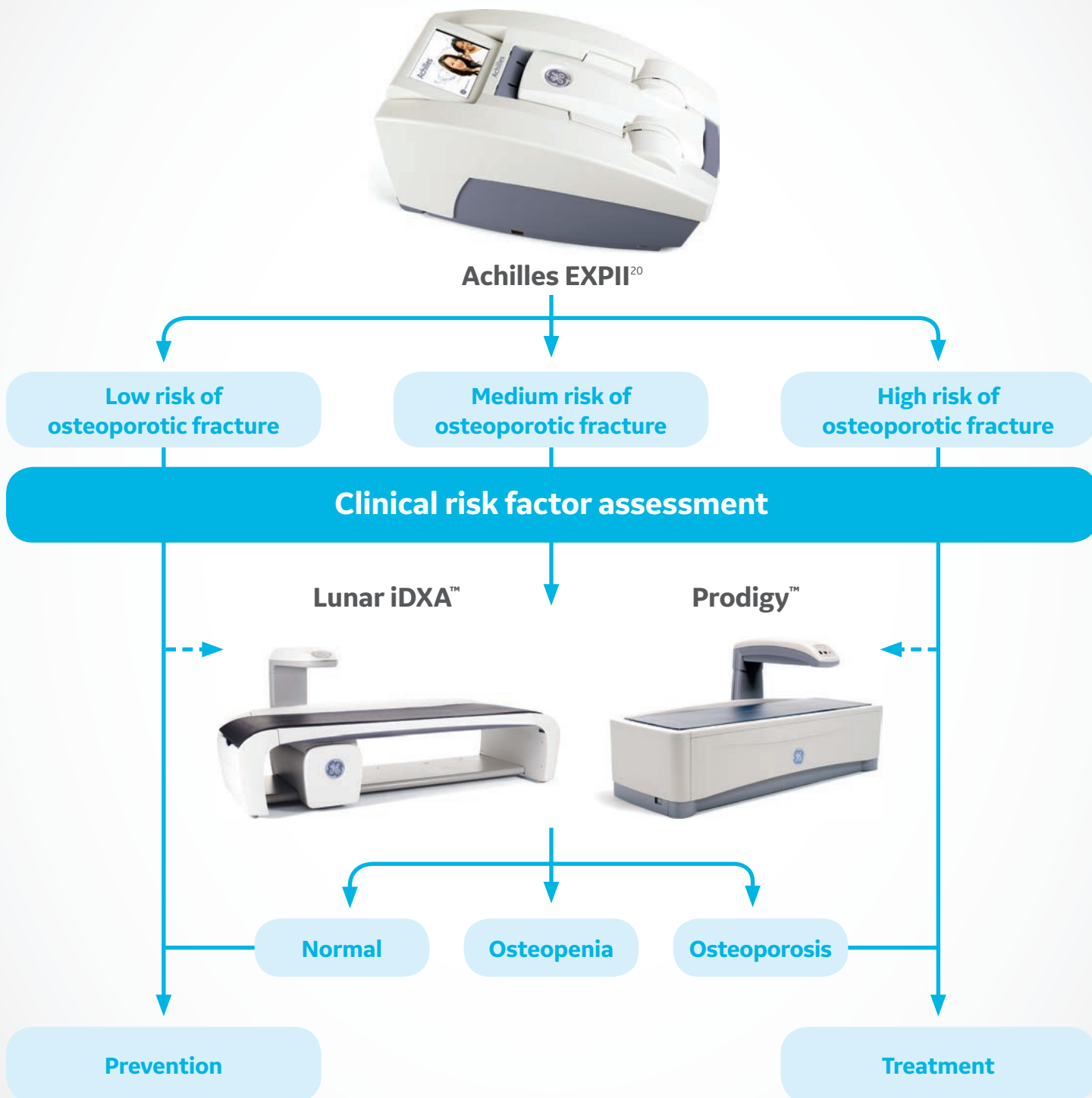

*“Quantitative ultrasound technology is inexpensive, portable, convenient and ionizing radiation free.”*

# The benefits of Achilles are supported by a range of features

## CERTAINTY

- Proven in 11 prospective clinical studies<sup>20</sup>
- High negative predictive value
- Dynamic signal-strength compensation allows measurement over a wide range of bone densities
- Bi-directional measurement helps ensure a consistent reading
- Controlled measurement of site temperature for greater accuracy than other QUS systems
- Results expressed as Stiffness Index – a composite of Speed of Sound (SOS) and Broadband Ultrasound Attenuation (BUA) – which compensates for the effect of heel width and temperature



For hospitals and physicians performing osteoporosis public health and education, the portable Achilles can be used as part of a skeletal health education program.

For hospitals and clinics needing risk stratification to determine which patients need follow-up with central DXA, the Achilles closely matches the prevalence of DXA-defined osteoporosis.

For clinics offering osteoporosis treatment to their patients, Achilles is an effective solution with proven, long-term precision monitoring.

## COMFORT

- No messy gels
- Warm, water-filled membranes hug the heel
- Built-in leg support
- Large, easy-to-read color display tilts towards the patient
- No ionizing radiation
- Quick exam – just a few minutes from shoe off to shoe on

## CONVENIENCE

- No special rooms
- Durable and easily portable
- Light-weight, compact design
- Generates full-sized and full-color reports
- On-board memory stores up to 2,000 patient records – no need to carry a computer
- Customizable measurement workflows allow you to select which patient data to collect and report
- Achilles EXP II can be operated through PC or laptop through OsteReportN (Optional purchase) software



# Osteoporotic fracture risk assessment as discriminating as DXA at the hip and spine

The osteoporotic fracture risk assessment provided by Achilles closely matches prevalence as defined by central DXA (see chart below).<sup>20</sup> Yet it's fast and affordable.

Its high negative predictive value – 97 percent for 50 to 59-year-old Caucasian women – makes Achilles especially useful for discriminating between those not at risk for fracture and those in need of further evaluation by central DXA.<sup>20,21</sup>

Additionally, Achilles has proven long-term precision, making it useful for monitoring bone changes.<sup>22,23,24</sup>

## Comparison of Achilles and competitive ultrasonometers to DXA for osteoporosis testing<sup>2</sup>

### Percentage of 60-year-old women that tested positive for osteoporosis

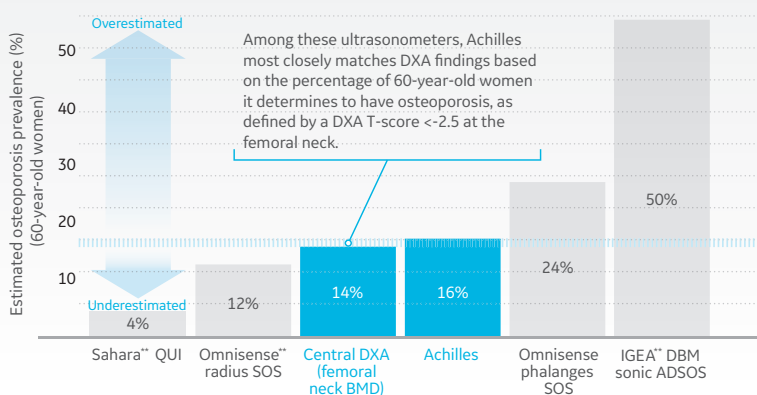

## Clinical confidence is based on many features:

- Dynamic signal strength compensation allows measurement over a wide range of bone density
- Bi-directional measurement ensures a consistent reading
- Measurement site temperature is controlled for more accuracy
- Results expressed as Stiffness Index – a composite of Speed of Sound (SOS) and Broadband Ultrasound Attenuation (BUA) – compensate for the effect of heel width and temperature

# Certainty

## The Achilles EXP II, the latest edition to the family of proven portable GE Achilles ultrasonometers, offers rugged durability, dynamic signal strength, and customizable workflow features

Compared to previous generation Achilles units, the EXP II offers:

- Longer lasting membranes (~3,000 - 5,000 scans per set vs. ~200 - 500 scans per set)
- Faster heel scan time (10 seconds vs. 60 seconds in previous model)
- Larger, easy-to-read color display
- External printer support via USB
- External USB data storage capability
- An on-board patient database that holds 2,000 patients.
- Faster internal printer speed (15 seconds vs. 60 seconds in previous models)
- Customizable measurement workflow





# Comfort

A quick and comfortable exam is the first step toward vitality.

With Achilles, the patient experience is pleasant. The exam is quick: just a few minutes from shoes off to shoes on. The patient is seated. No messy gels are needed. Its ultrasound technology emits no ionizing radiation.

Inflated membranes hug the heel.



A large, easy-to-read color display tilts back and forth.

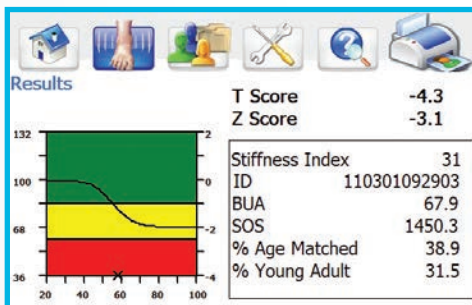

# Convenience

Efficient, customizable workflow.

Your staff will appreciate the simplicity of Achilles. It's easy for technicians to learn and to use, and it requires no special rooms, no formal certification, and no licensing. Results are concise and easy to interpret.

Along with rugged durability, Achilles boasts plenty of technical features. A large, easy-to-read color display tilts back and forth. Reports print out in full color and full size. The on-board memory stores up to 2,000 patient records. And customizable measurement workflows allow you to select which data to collect and report:

- Prevalence data
- Clinical risk factors
- Patient identification data

# Portable

Convenient, light-weight, compact design



## Portability Options



Padded Travel Bag without cart



Travel Cart



Hard Sided Shipping Case

## Operating Achilles EXPII is quick and easy

Achilles EXPII is easy to operate and the entire scan just takes 1-2 minutes.

### Ease of use

- Fixed transducers
  - No imprecise caliper mechanism
- Temperature controlled water
  - Now self-contained
  - Water-path ultrasound provides the most accurate and most precise results
- Position the heel and measure
  - Simple slide heel between the membranes





# OsteoReportN

Achilles OsteoReportN is an external PC application option that enhances the functionality of the Achilles with:

- Patient database
- Customizable reporting
- Remote operation
- DICOM® compatibility



OsteoReportN plots measurement results over time to visualize trends in your patient's fracture risk and automatically recalculates clinical results if patient data is updated.

Easy to understand educational material can be printed with the results to help you explain the results and next steps for your patient.

You can conveniently operate the Achilles EXP11 unit directly from your PC. Also, OsteoReportN is DICOM compatible.

## **Achilles OsteoReportN application requires a PC computer with the following minimum requirements:**

- PC with 2Ghz CPU or higher
- 512MB of RAM or higher
- 8 Gigabyte of available space on hard drive or higher
- Windows® XP (SP3) 32 bit or Windows 7 64 bit
- Keyboard and Microsoft® Mouse or compatible pointing device
- Super VGA (1024 x 768) or hi-resolution video adapter & monitor
- CD ROM
- Windows-compatible color printer capability
- USB 2.0 Port
- USB Cable

## **Achilles OsteoReport application also requires:**

An Achilles EXP11 running firmware version 1.50 or higher





# Achilles EXP II results

- Easy-to-read LCD display
- Tiltable/reversible for operator convenience
- View waveforms and results

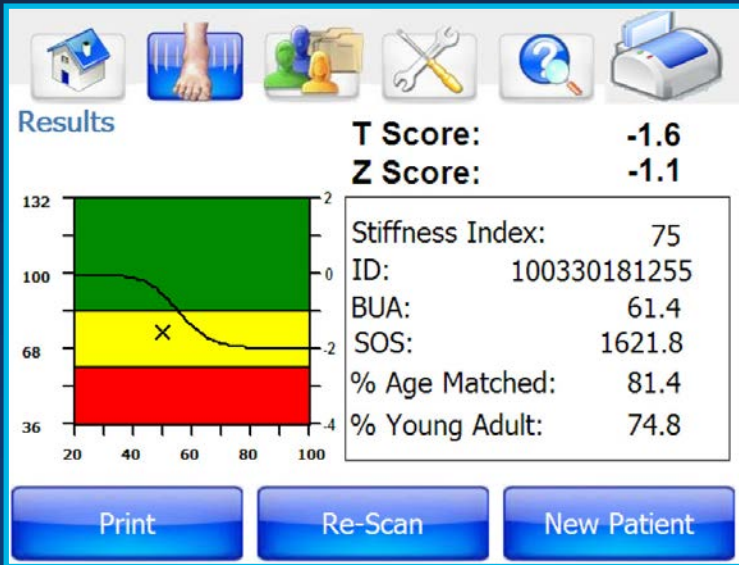

Achilles	
unit	SN
	M
ID	100330181255
DATE	2010/03/30
TIME	18:12:33
STIFFNESS INDEX	75
AGE	50
SEX	Female
FOOT	Left
REFERENCE	USA
BUA	61.4
SOS	1621.8
% YOUNG ADULT	75
T SCORE	-1.6
% AGE MATCHED	81
Z SCORE	-1.1

Simply attach to pre-printed color report

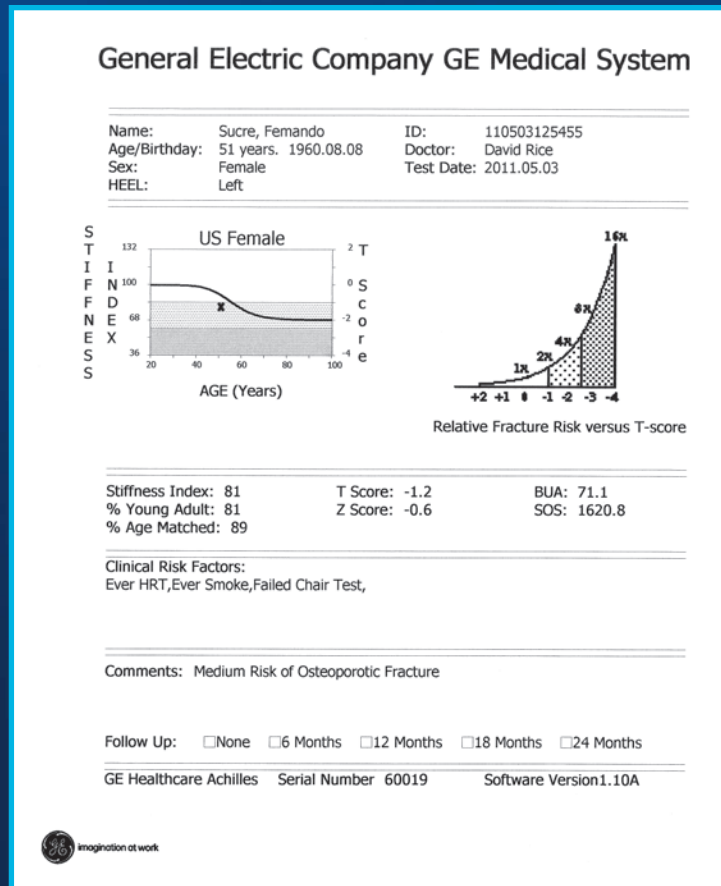

# Achilles comparison table



Product name	Achilles EXP11	Previous Model – Achilles Express*	Previous Model – Achilles InSight*
Scanning site	Heel	Heel	Heel
Scanning method	QUS with SmartDry coupling	QUS with SmartDry coupling	QUS with SmartDry coupling
Membrane life (# of measurements)	<b>~3000</b>	~200	~200
Membrane color	White/thicker – not interchangeable with AE & A)	Tan/thin	Tan/thin
Heel scan time (seconds)	10	60	15
QA test duration (seconds)	30	60	30
Foot positioning	<b>Graduated foot plate (without toe peg)</b>	Foot plate (with toe peg)	Graduated foot plate (with toe peg)
Heel coupling method	Alcohol	Alcohol	Alcohol
Precision	2% CV	2% CV	2% CV
Display	<b>6.5" color LCD VGA (640 x 480 pixels)</b>	5.5" B&W LCD (320 x 240 pixels)	5.5" color LCD (320 x 240 pixels)
Touch panel response time	2X	1X	2X
Touch method	Stylus or finger	Finger	Finger
Image	No	No	Yes
External printer support	<b>Yes (USB)</b>	No	Yes (Serial: need adaptor)
Internal printer	58 mm thermal	58 mm thermal	58 mm thermal
Internal printer speed (seconds)	<b>15</b>	60	60
Internal printer report format	5 selectable report settings	Fixed	5 selectable report settings
Patient data input fields	<b>17</b>	4	11
Shims/smaller feet	1 raised shim (Identical to Express)	1 raised shim	1 raised shim
Water replacement period			
– Light use (<10 measurements/day)	4½ months	4½ months	4½ months
– Heavy use (>50 measurements/day)	2 weeks	2 weeks	2 weeks
Data storage/internal memory/# of patients	<b>2000</b>	100	300
Data storage – External USB	<b>USB 2.0 thumb drive</b>	---	---
Database/reporting application	---	OsteoReport	OsteoReport
Weight	11.5 kg (25.4 lbs)	11.5 kg (25.4 lbs)	11.5 kg (25.4 lbs)
Physical dimensions	275 mm x 305 mm x 550 mm 11" H x 12" W x 22" D	281 mm x 305 mm x 560 mm 11" H x 12" W x 22" D	281 mm x 305 mm x 560 mm 11" H x 12" W x 22" D
Measurement workflow	<b>Customizable</b>	Not customizable	Not customizable
Color	<b>White over dark gray</b>	Beige over gray	Beige over gray

\*This model is no longer being offered by GE Healthcare

# Specifications (nominal)

## Reference populations:

	AF	AM	PF	PM		AF	AM	PF	PM
Japanese	X	X	X	X	Italian	X	X		
German	X	X			Middle East	X			
European	X				Chinese	X	X		
French	X				Greek	X			
Latin American	X	X			Saudi Arabian	X			
Mercosurian	X	X			USA	X			

## Specifications:

Dimensions	275 mm x 305 mm x 550 mm (11" H x 12" W x 22" D)
Weight	11.5 kg (25.4 lbs.)
Display	<ul style="list-style-type: none"> <li>6.5" Color LCD VGA (640 x 480) with graphical display</li> <li>Tilts and inverts for optimal viewing</li> <li>Brightness <math>\geq 400\text{cd/m}^2</math></li> </ul>
Printer	<ul style="list-style-type: none"> <li>Internal 58 mm thermal printer with graphical output</li> <li>Print report <math>\leq 15</math> seconds</li> <li>Specific external printer support for A4 size paper</li> </ul>
USB port	<ul style="list-style-type: none"> <li>USB2.0</li> <li>USB Host x 2, USB Slave x 1</li> </ul>
Battery	<ul style="list-style-type: none"> <li>CR2032 +3V</li> <li>Inside device, customer dose not required to replace it</li> </ul>
Power Consumption	650VA without peripherals
Transducers	<ul style="list-style-type: none"> <li>Quarter wave-matched broadband elements</li> <li>Center frequency = 0.5 MHz</li> <li>Single element transmission and reception</li> </ul>
Output power of Ultrasound	<ul style="list-style-type: none"> <li>p-&lt; 1 MPa</li> <li>lob&lt; 20 mW/cm<sup>2</sup></li> <li>Ispta&lt; 100 mW/cm<sup>2</sup></li> </ul>
Coupling System	<ul style="list-style-type: none"> <li>SmartDry™</li> <li>Fluid-coupled, through-transmission ultrasound</li> <li>Fully automated and self-contained</li> <li>Heated coupling fluid 33°C (92°F)</li> <li>70% Isopropyl Alcohol or Ethanol</li> <li>Replaceable TPE (Thermoplastic elastomer) Membranes</li> <li>Pressure &lt; 3 psi</li> </ul>
Analysis	<ul style="list-style-type: none"> <li>Real-time, point-by-point analog/digital conversion</li> <li>Smart detection algorithm, Discrete Fourier Transform</li> <li>Simultaneous Stiffness/SOS/BUA determination</li> </ul>
Results	<ul style="list-style-type: none"> <li>Stiffness Index with WHO classification</li> <li>T-Score with % Young Adult</li> <li>Z-Score with % Age-Matched</li> </ul>
In Vivo Precision and Accuracy	< 2.0% CV (ambient temperatures between 15°C and 33°C)
Scan Throughput	10 seconds Signal Acquisition
Warm up	$\leq 15$ minutes from 4°C
Expected Service Life	6 years

## Electrical Requirements:

Voltage	100–240V AC @50/60 Hz
Power Capacity	$\geq 650\text{VA}$
THD (Total Harmonic distortion)	< 5% per IEEE 519-1992 standard for power quality and total harmonic distortion

**WARNING:** To avoid the risk of electric shock, this equipment must only be connected to a supply main with protective earth.

## Environmental Requirements:

Operating ambient	Temperature: 15°C ~ 35°C, Humidity: 30 – 90%RH (non-condense),
Storage/Transport ambient	Temperature*: -20°C ~ 70°C, Humidity: 30 – 95%RH (non-condense)
Static	Static-free environment
Dust, fumes, and debris	Clean, well ventilated environment, free from dust, smoke, and other airborne contaminants
External cleaning agents	Clean, well ventilated environment, free from dust, smoke, and other airborne contaminants

Temperature\*: Pump shall be no more than half full of water when the temperature is below 0°C

## Dimensions:

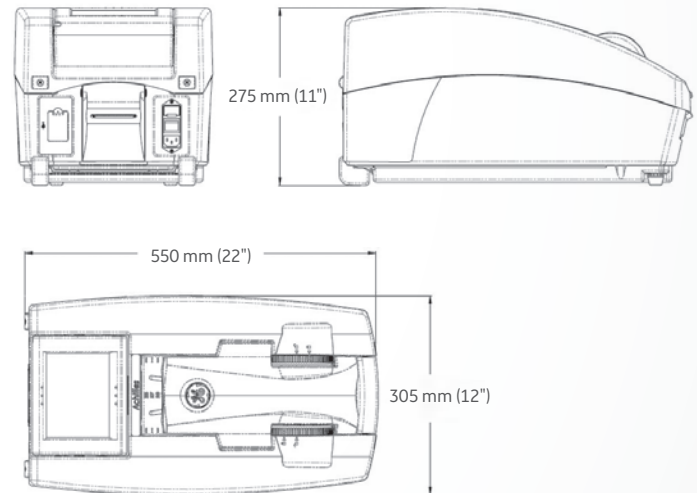



## References:

1. International Osteoporosis Foundation.
2. Zagzebski JA, Rossman PJ, Mesina C, Mazess RB, and Madsen EL. (1991) Ultrasound transmission measurements through the os calcis. *Calcif Tissue Int* 49:107–111.
3. Rossman P, Zagzebski J, Mesina C, Sorenson J, Mazess R. (1989) Comparison of ultrasonic velocity and attenuation in the os calcis to photon absorptiometry measurements in the radius, femur, and lumbar spine. *Clin Phys Physiol Meas* 10:353–360.
4. Langton CM, Palmer SB, and Porter RW. (1984) The measurement of broadband ultrasonic attenuation in cancellous bone. *Eng Med* 13:89–91.
5. Hans D, Schott AM, and Meunier PJ. (1993) Ultrasonic assessment of bone: a review. *Eur J Med* 2(3):157–163.
6. Hans D, Fuerst T, Duboef F. (1997) Quantitative ultrasound bone measurement. *Eur Radiol* 7 (Suppl 2):S43–S50.
7. Bouxsein ML, Radloff SE. (1997) Quantitative ultrasound of the calcaneus reflects the mechanical properties of calcaneal trabecular bone. *J Bone Miner Res* 12:839– 846.
8. Han S, Medige J, Davis J, Fishkin Z, Mihalko W, Ziv I. (1997) Ultrasound velocity and broadband attenuation as predictors of load-bearing capacities of human calcanei. *Calcif Tissue Int* 60:21–25.
9. Duquette J, Lin J, Hoffman A, Houde J, Ahmadi S, Baran D. (1997) Correlations among bone mineral density, broadband ultrasound attenuation, mechanical indentation testing, and bone orientation in bovine femoral neck samples. *Calcif Tissue Int* 60:181–186.
10. Njeh CF, Hodgskinson R, Currey JD, Langton CM. (1996) Orthogonal relationships between ultrasonic velocity and material properties of bovine cancellous bone. *Med Eng Phys* 18:373–381.
11. Langton CM, Njeh CF, Hodgskinson R, Currey JD. (1996) Prediction of mechanical properties of the human calcaneus by broadband ultrasonic attenuation. *Bone* 18:495– 503.
12. Hodgskinson R, Njeh CF, Whitehead MA, Langton CM. (1996) The non-linear relationship between BUA and porosity in cancellous bone. *Phys Med Biol* 41:2411– 2420.
13. Laugier P, Droin P, Laval-Jeantet AM, Berger G. (1997) In vitro assessment of the relationship between acoustic properties and bone mass density of the calcaneus by comparison of ultrasound parametric imaging and quantitative computed tomography. *Bone* 20:157–165.
14. Tavakoli MB and Evans JA. (1991) Dependence of the velocity and attenuation of ultrasound in bone on the mineral content. *Phys Med Biol* 36:1529–1537. A-6 Theory of Ultrasound Achilles InSight/Express Operator's Manual
15. Evans JA and Tavakoli MB. (1990) Ultrasonic attenuation and velocity in bone. *Phys Med Biol* 35:1387– 1396.
16. Hans D, Arlot ME, Schott AM, Roux JP, Kotzki PO, Meunier PJ. (1995) Do ultrasound measurements on the os calcis reflect more the bone microarchitecture than the bone mass?: a two-dimensional histomorphometric study. *Bone* 16:295–300.
17. Gluer CC, Vahlensieck M, Faulkner KG, Engelke K, Black D, and Genant HK. (1992) Sitematched calcaneal measurements of broad-band ultrasound attenuation and single x-ray absorptiometry: do they measure different skeletal properties? *J Bone Miner Res* 7:1071–1079.
18. Nicholson PHF, Haddaway MJ, Davie MWJ. (1994) The dependence of ultrasonic properties on orientation in human vertebral bone. *Phys Med Biol* 39:1013–1024.
19. Clarke AJ, Evans JA, Truscott JG, Milner R, Smith MA. (1994) A phantom for quantitative ultrasound of trabecular bone. *Phys Med Biol* 1677–1687.
20. Krieg M-A, Barkmann R, Gonnelli S, et al. Quantitative Ultrasound in the Management of Osteoporosis: The 2007 ISCD Official Positions. *J Clin Densitom: Assessment of Skeletal Health*. 2008; 11 (1): 163-187.
21. Simon D, Boring III JR. Chap. 6: Sensitivity, Specificity, and Predictive Value. In: HK Walker, WD Hall, JW Hurst, ed. *Clinical Methods: The History, Physical, and Laboratory Examinations*, 3<sup>rd</sup> edition. Boston: Butterworths; 1990.
22. Gonnelli S, Cepollaro C, Pondrelli C, Martini S, Rossi S, Gennari C. Ultrasound parameters in osteoporotic patients treated with salmon calcitonin: A longitudinal study. *Osteoporos Int*. 1996; 6 (4): 303-307.
23. Giorgino R, Paparella AP, Lorusso D, Mancuso S. Effects of oral alendronate treatment and discontinuance on ultrasound measurements of the heel in postmenopausal osteoporosis. *North American Menopausal Society*, September 1996.
24. Gonnelli S, Cepollaro C, Montagnani A, et al. Heel ultrasonography in monitoring alendronate therapy: a four-year longitudinal study. *Osteoporos Int*. 2002; 13 (5): 415-421.



© 2017 General Electric Company – All rights reserved.

GE Healthcare reserves the right to make changes in specifications and features shown herein, or discontinue the product described at any time without notice or obligation. Contact your GE Healthcare representative for the most current information. GE, the GE Monogram, Lunar iDXA and Prodigy are trademarks of General Electric Company. GE Healthcare, a division of General Electric Company. GE Medical Systems, Inc., doing business as GE Healthcare.

October 2017  
JB52895XX