



Prodigy™ from GE Healthcare

Most trusted, reliable and best-selling DXA system
with one of the largest installed base in the world



Prodigy

High performance, efficient and reliable DXA system with the versatility to offer bone density test and body composition analysis and the flexibility to scale up to a wide-range of clinical applications.

Available in
Full or **Compact**
sizes.



The flexibility of full size and compact size DXA systems meets the different space requirements of your clinic



Advance Software Package

Advanced skeletal and metabolic health assessment



Pro Software Package

Essential skeletal and metabolic health assessment



Primo Software Package

Essential skeletal health assessment

Solid performance makes Prodigy chosen worldwide.

Prodigy is our proven and dependable DXA product with a large global installed base across 120+ countries.

Your practice demands dependable dual-energy X-ray absorptiometry (DXA) assessment, and Prodigy delivers with exceptional precision and low-dose radiation. You can depend on Prodigy to provide precise data on soft tissue and bone composition, including bone-mineral density (BMD), lean- and fat-tissue mass, and percentage of fat. At the same time, Prodigy streamlines your patient care and practice workflow.

**Over 14,500 Prodigy
installations in more than
120 countries.**

Why Prodigy?

In addition to proven performance, reliability and large installed base, our customers prefer Prodigy because:

- Flexibility to offer Bone Health and Metabolic Health diagnosis (Full Size Prodigy Only)
- Two possible sizes (Full and Compact) to suit space requirements of your clinic
- Enhanced workflow and process improvement tools
- Wide range of clinical applications to choose from
- Scalability to upgrade to new clinical applications in the future

Clinicians, Researchers and Practitioners have trusted the Prodigy DXA system for more than 20 years making it one of the largest selling DXA systems in the world.



Prodigy for Bone Health and Metabolic Health



With its reliable design, robust technology and breadth of clinical applications for bone health (Bone Mineral Density, FRAX, Trabecular Bone Score and many more), Prodigy is a suitable platform for your bone health diagnostic needs.

The flexibility of Full size and Compact size systems meets the different space requirements of your clinic.

Bone Health

Prodigy offers a wide range of clinical applications for your metabolic health needs (Body Composition, Color Coding, CoreScan, and many more).

You can always scale-up to upgrade your Prodigy system with more clinical applications in the future as your needs change with time. Starting with version 14, Prodigy offers the enhanced analysis option for total body scans that applies improved algorithm for body composition precision and image resolution giving you higher quality results.



*Full Size Prodigy only

Metabolic Health and Body Composition

Efficiency

Optimal patient and practice management

Prodigy empowers you with efficient workflow and performance for accurate bone mineral density (BMD) and other body composition analyses. Prodigy's advanced features not only help your DXA scanning process flow with ease, but they also enable you to manage your patient data and business more effectively.

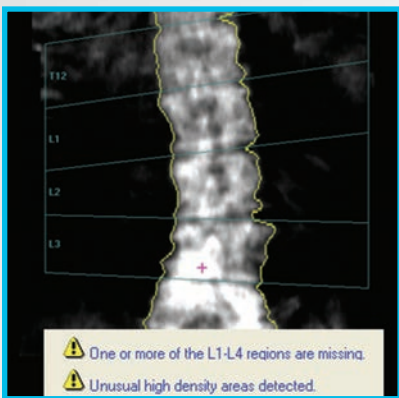

ScanCheck application automatically identifies potential errors in artifact identification, acquisition, and analysis – and provides correction instructions.

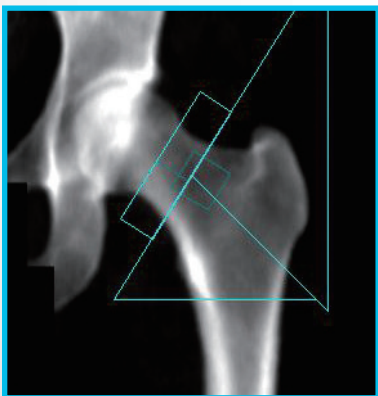

Automatic ROI placement eliminates the need for user intervention, enables consistency from one exam to the next, and increases precision.



OneScan performs an AP Spine and DualFemur exam without repositioning between scans. OneScan does not use the foam leg block positioner for spine positioning. This feature also provides the option to detect if patient has had a previous scan through OneScan, thereby allowing trending of DXA measurement results. For previous exams, the operator can also determine if the OneScan feature was on or off through examination of the analysis screen under the Information tab in the enCORE software.

QuickView offers speed and efficiency to high turnaround clinics by offering a fast, 10 second spine or femur scan. QuickView is one of the scan modes along with other scan modes – thick, standard, and thin. Depending on the patient, the software will select a recommended scan mode, but the operator is always free to view the QuickView mode to achieve faster scan time and throughput.

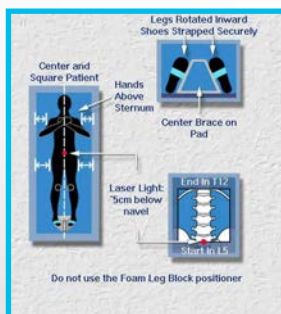
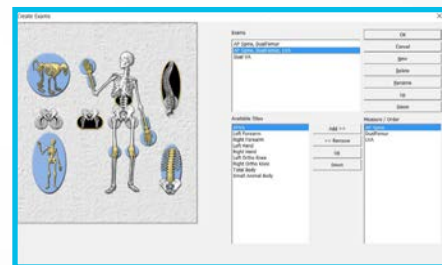

The **OneVision** feature allows you to set up multiple measurements in one exam. This eliminates keystrokes and improves throughput for operators that routinely perform multiple measurements on each patient. OneVision allows you to select multiple skeletal sites during an exam such as AP Spine, Dual Femur, LVA, Dual VA (LVA + APVA), Forearm, Hand, Knee, and Total Body.

Robust Technology Foundation

Third generation DXA technology – with over 30 years of innovations since the first bone densitometry FDA clearance in 1980, including:

- Narrow-angle fan-beam with MVIR – that minimizes magnification error¹
- Photon Counting LYSO scintillator crystal detector – that improves image quality and lowers dosage compared to competitive systems^{2, 3}
- Exceptional precision

Narrow Fan Beam Scan

Patented narrow fan beam technology that combines the best features of pencil beams (no magnification, low dose) with the short scan time of wide fan beams while reducing magnification error inherent to wide-angle fan beam systems.

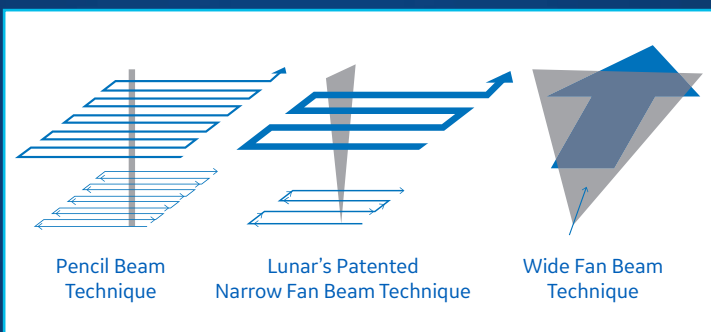

Photon Counting Detector

Dose-efficient photon counting detector technology that simultaneously counts low and high energy X-rays photons resulting in lower dosage to the patient and faster and efficient scans.

SmartScan™

Unique feature exclusive to GE Healthcare bone densitometry systems that identifies bone regions after each transverse sweep to estimate where to begin exposing the patient to X-rays on the subsequent sweep, thereby reducing the scan time and the dose to the patient.

K-edge Filter

A stable X-ray source with “K-edge filter” that absorbs the X-rays in the middle energy range and protects the patient against unnecessary exposure.

Multi-View Image Reconstruction (MVIR)

Using narrow fan beam technology to perform multiple, spaced and transverse sweeps across the site of interest resulting in accurate determination of bone-height above the tabletop, minimization of magnification errors, and thereby providing higher precision and accuracy.

Low Scattered Radiation

Due to narrow fan beam technology, low scatter radiation in comparison to wide angle fan beam systems.

Relative intrinsic performance comparison of DXA beam types

	Pencil Beam	Narrow Fan	Wide Fan
Scan time	Long	Short	Short
Bone height measured	No	Yes	No
Magnification effects	No	No	Yes
Off-center distortions	No	No	Yes
SmartScan	Yes	Yes	No
Scattered radiation	Lowest	Low	High

Flexibility to meet today's productivity demands

Workflow efficiency is critical in today's clinical environment, and Prodigy is uncompromising on this point. It adapts to the needs of your DXA business with tools for connectivity, remote service, and practice management.



MULTI-USER DATABASE
lets you network the way you want.

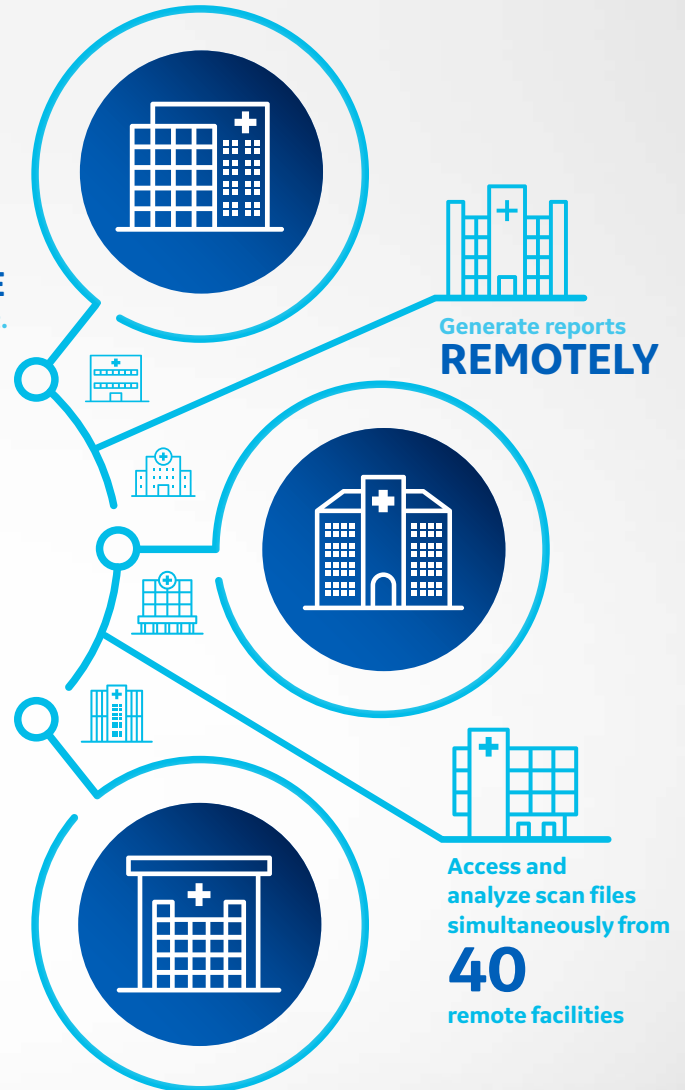

Acquire and save images from multiple GE densitometers to a common database.

Detailed assessment in just a few clicks



OneScan performs spine and dual femur BMD measurements in a single acquisition without repositioning.² Results print in a one-page report.

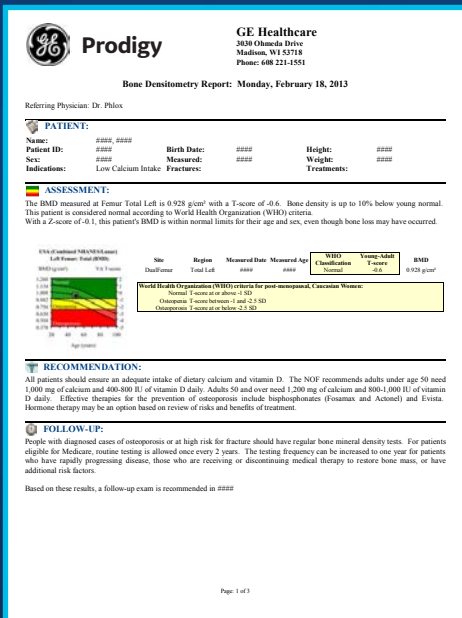
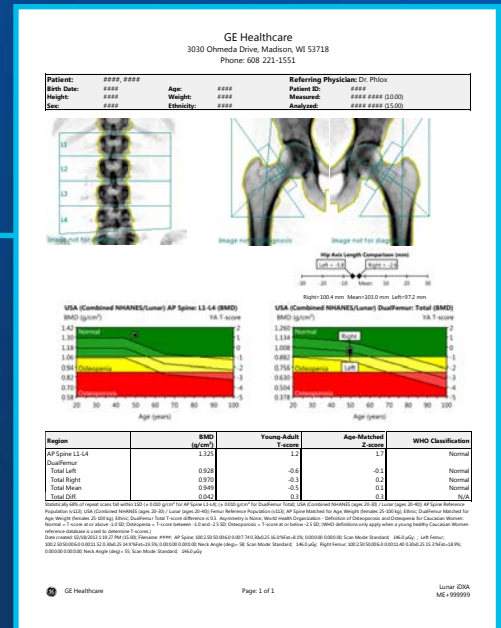

Fully customizable reports can be made as concise or as detailed as needed.

Treatment recommendations designated by the physician are automatically added and can include society guidelines.

General purpose business reporting tools help you manage your practice. Prodigy will automatically:

- Generate referring physician letters
- Analyze populations and trends
- Export data to tab-delimited text files for use in Microsoft® Excel®

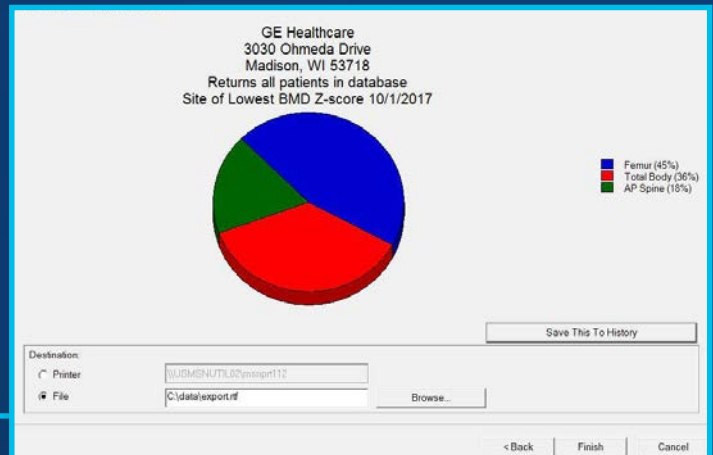

Breadth of applications and features for a wide range of patients

A long list applications for Prodigy with the enCORE software platform – from visceral fat measurement, color fat mapping and pediatric assessment to small animal scanning – helps explain why it's chosen by leading hospitals, clinics, and physicians around the world.

BMD

Measures the bone mineral density of a preferred skeletal site that can be compared to an adult reference population at the sole discretion of the physician. Generates a reference chart with Z-score and T-score.

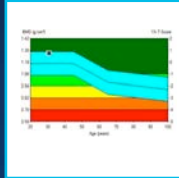

Dual-energy Vertebral Assessment (DVA)

Lateral and anterior views of the spine with soft tissue equalization to identify vertebral deformations. Performs both LVA and APVA in one protocol.



FRAX®

FRAX 10-Year Fracture Risk provides an estimate of 10-year probability of hip fracture and 10-year probability of a major osteoporotic fracture for men and post-menopausal women ages 40-90 years.



AP Spine

Provides an estimate of bone mineral density for the lumbar spine.

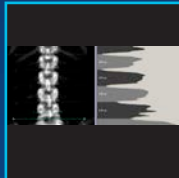

Lateral Spine Measurement

Lateral Spine measurement and analysis provides an estimate of bone mineral density for the lumbar spine.

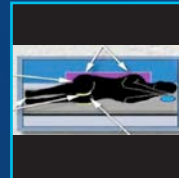

Hand Measurement

Hand measurement and analysis provides an estimate of the bone mineral density for the hand.

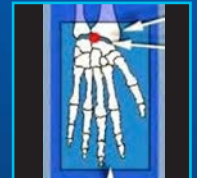

Femur/ Dual Femur

Measures both single femur or both the femurs in one scan, helping you assess the weakest femur through measuring bone mineral density for the proximal femur.



Hip Axis Length (HAL)

Measurement of the distance along the femoral neck axis, extending from the bone edge at the base of the trochanter to the bone edge at the inner pelvic brim.



Forearm

Measures radius and ulna, providing additional clinical information on BMD for the distal forearm. This measurement can be taken in both sitting or supine position.



Color Coding†

Color coding can be used to code bone, lean tissue and fat tissue.



Pediatrics

Pediatric measurement and analysis feature provides BMD, BMC, fat mass, and lean mass for patients from birth to 20 years old.

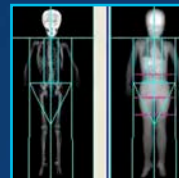

CoreScan™†

CoreScan software feature estimates the VAT (Visceral Adipose Tissue) mass and volume within the android region.



LVA Morphometry & Spine Geometry

LVA Morphometry measurement and analysis provides an X-ray image of the spine for qualitative visual assessment in order to identify vertebral deformations and estimate vertebral heights (morphometry), while LVA and APVA Spine Geometry measure Cobb angles.



Atypical Femur Fracture (AFF)*

AFF measurement and analysis provides an X-ray image of the entire femur for both qualitative visual assessment and quantitative measures in order to identify areas of focal thickening along the lateral cortex of the femoral shaft.

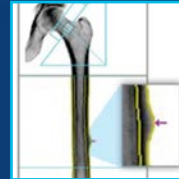

MirrorImage Scan†

The MirrorImage function can be used to estimate the total body composition and bone mineral density (BMD) when regions of the body are outside of the scan window by using scanned data from the corresponding region(s) on the opposite half of the body.

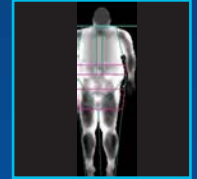

*Feature only available with enCORE version 17

†Metabolic Health applications and Body Composition is offered in Prodigy Full Size only

Breadth of applications and features for a wide range of patients

OneVision

The OneVision feature allows you to set up multiple measurements in one exam. This eliminates keystrokes and improves throughput for customers that routinely perform multiple measurements on each patient.

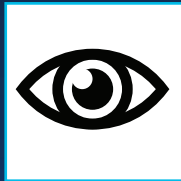

Metabolic Information[†]

Provides insight on metabolic information such as Resting Metabolic Rate (RMR) and Relative Skeletal Muscle Index (RSMI) with ability to capture Total Body Water (TBW), Intracellular Water (ICW), & Extracellular Water (ECW).



Body Composition - Total/Regional[†]

Performs total body scan to measure bone mass, lean mass and fat mass. Also measures regional and whole body bone mineral density (BMD), lean and fat tissue mass.

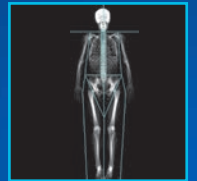

Trabecular Bone Score™ (TBS)

Provides trabecular bone score based on bone structure assessment of the trabecular region of the bone.

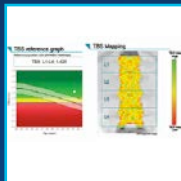

Practice Management

Provides general-purpose business reporting tools to view existing patient population as well as follow-up on next site visit.



Orthopedic Knee

Orthopedic Knee measurement and analysis provides an estimate of the bone mineral density around knee implants pre- and post-surgery.



Small Animal Body Scan[†]

Small Animal measurement and analysis is for investigational use on laboratory animals or for other tests that do not involve human subjects.

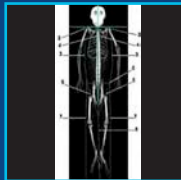

Custom Reference Population

Physicians can create a custom reference population and use that population for comparison to your patients' results.



Patient BMD Trending

Monitoring tool to view changes in a patient's BMD over time. To view trending results, all of the trended measurements must be from the same site.

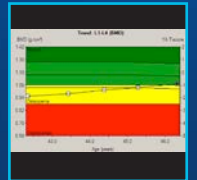

Orthopedic - Hip Implant

Measure the delicate region around the hip implant and visualizes 19 Gruen zones.



OneScan

OneScan performs an AP Spine and Dual Femur exam without repositioning between scans.

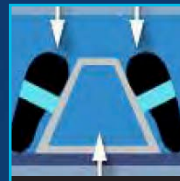

ScanCheck

ScanCheck assists the user in detecting Spine, Femur, Forearm and Total Body abnormalities.



Composer

Composer feature provides many pre-generated report formats as well as ability to create custom reports.



Multi-User Database Access

Allows up to 40 remote computers to be connected with a common patient database allowing multiple users to access and analysis patient data.



Sarcopenia**

Sarcopenia software calculates values based on published definitions and thresholds using measured appendicular lean mass in combination with patient demographics and entered values of muscle strength and physical performance.



QuickView

QuickView offers a fast, 10 second spine or femur scan. Measurement and analysis procedures are the same as other scan modes.



*Feature only available with enCORE version 17

†Metabolic Health applications and Body Composition is offered in Prodigy Full Size only

Specifications

Scanner dimensions:

Full-size bed⁴:

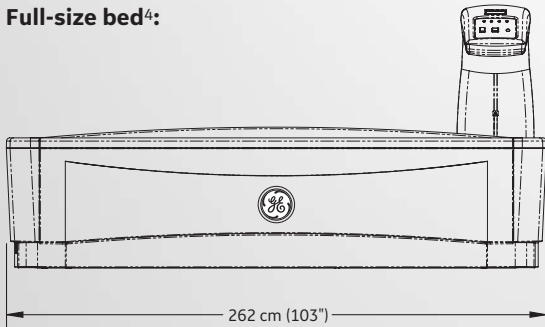

Compact bed:

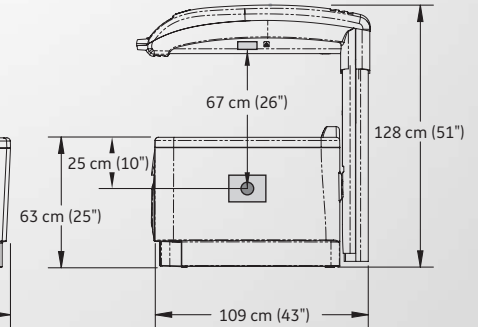
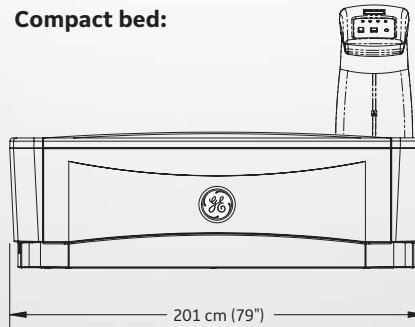

Minimum room dimensions⁵

Full-size bed⁴:

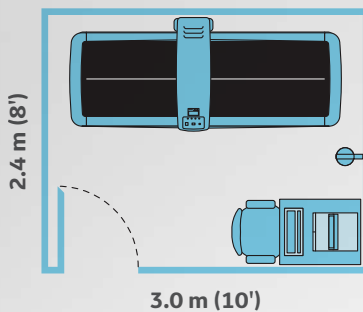

Compact bed:

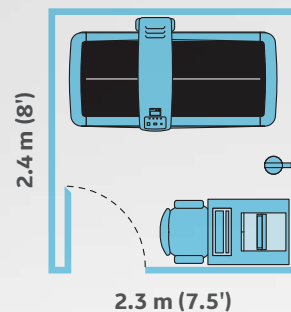

Minimum Computer Specifications:

- Intel® Core™ i3 Processor
- Windows® 7 Professional 32-bit or 64-bit with SP1
- RAM 2 GB
- Hard Drive 250 GB; 1 GB must be available for enCORE
- Optical Drive DVD-R
- Monitor 17" SVGA (minimum resolution 1024x768 32 bit color)
- Archive 320 GB USB hard drive
- Internet Explorer 11
- Adobe Reader 9.0 or greater
- Windows®-compatible printer
- Serial port Onboard RS-232 115k baud DB-9

Scanner table specifications:

Scanner size (full-size bed)	262(W) x 109(D) x 128(H) cm (103" x 43" x 51")
Scanner size (compact bed)	201(W) x 109(D) x 128(H) cm (79" x 43" x 51")
Scanner weight (full-size bed)	272 kg (599 lbs)
Scanner weight (compact bed)	254 kg (559 lbs)
Patient table top height (adjustable).....	>63 cm (25")
Drive system	stepper motor with reinforced drive belts
Active scan area (full-size bed)	196 cm x 60 cm
Active scan area (compact bed)	134 cm x 60 cm
Start position indicator	cross laser light (class II, <1 mW power)
Pad	washable patient mat
Attenuation of patient support table	<0.7 mm AL
Communication cable	7.62 m (25 ft) serial
Scanner leakage current	meets IEC 60601-1 safety standard

Detector specifications:

Detector LYSO X-ray counting detector

Environmental specifications

Power.....	100-120 VAC 50/60 Hz 20A dedicated circuit 220-240 VAC 50/60 Hz 10A dedicated circuit
Consumption	Idling 40VA, Scanning 450VA
Distortion.....	sinusoidal waveform, less than 5% THD
Humidity.....	20%-80% non-condensing
Room temperature.....	18°C-27°C (65°F-81°F)
Scanner heat output	idling 150 BTU/hr, scanning 1500BTU/hr
Console heat output	approx. 400BTU/hr with 17" monitor
Ventilation	all cooling vents must remain unblocked
Dust, fumes, debris.....	install system in clean, ventilated area



Software Features[†]:

Prodigy Advance Full

Standard:

- AP Spine
- Dual Femur
- Femur
- Forearm
- Nonseated Forearm
- Total Body BMD
- FRAX[®] Fracture Risk Tool
- DVA (Includes: LVA, APVA, Lateral BMD)
- Orthopedic Hip
- Total Body Comp
- Pediatric – TB (Birth to 20 YO)
- Pediatric – AP Spine
- Pediatric – Femur
- Advanced Body Comp
- Advanced Hip Analysis
- HL7
- DICOM[®]
- Multiuser dB (1-3)
- Teledensitometry
- ScanCheck
- Practice Management
- Composer
- OneScan
- OneVision
- Quick View
- SQL Database

Optional:

- Sarcopenia
- Atypical Femur Fracture
- Orthopedic Knee
- Multiuser Database (1-40)
- Hand
- Small Animal
- USB External DVD Read/Write Drive
- Encapsulated Phantom
- Orthopedic Knee with Positioner for IB
- CoreScan[™]
- Trabecular Bone Score (TBS)

Prodigy Pro Full/Compact

Standard:

- AP Spine
- Dual Femur
- Femur
- Forearm
- Nonseated Forearm
- Total Body BMD*
- FRAX Fracture Risk Tool
- DVA (Includes: LVA, APVA, Lateral BMD)
- Total Body Comp*
- HL7
- DICOM
- Multiuser dB (1-3)
- Teledensitometry
- ScanCheck
- Practice Management
- Composer
- OneScan
- OneVision
- SQL Database

Optional:

- Sarcopenia*
- Atypical Femur Fracture
- Advanced Body Comp*
- Orthopedic Hip
- Orthopedic Knee
- Multiuser Database (1-40)
- USB External DVD Read/Write Drive
- Encapsulated Phantom
- Orthopedic Knee with Positioner for IB*
- CoreScan*
- Trabecular Bone Score (TBS)

Prodigy Primo Full

Standard:

- AP Spine
- Dual Femur
- Femur
- Forearm
- Nonseated Forearm
- Total Body BMD
- FRAX Fracture Risk Tool
- DVA (Includes: LVA, APVA, Lateral BMD)
- HL7
- DICOM
- Multiuser dB (1-3)
- Teledensitometry
- ScanCheck
- Practice Management
- Composer
- OneScan
- OneVision
- SQL Database

Optional:

- Basic Body Composition
- Sarcopenia
- Multiuser Database (1-40)
- USB External DVD Read/Write Drive
- Encapsulated Phantom
- CoreScan
- Trabecular Bone Score (TBS)

[†]Product Specification for US & Canada Only. For Product Specifications for your country, please contact your local GE Sales Representative.

*Prodigy Pro Full Only

**Prodigy Pro Compact Only



References:

1. Boudousq V. (2004) Image Resolution and Magnification Using a Cone Beam Densitometer: Optimizing Data Acquisition for Hip Morphometric Analysis; Osteoporos Int. 2005 Jul;16(7):813-22. Epub 2004 Oct 16.
2. S.M. Hunt et al, "Changing Bone Densitometers in Clinical Practice: Effect on Precision Error", Presented at the American Society for Bone and Mineral Research Annual Meeting, September 23-27, 2005, Nashville, TN, USA.
3. Dose comparison based on information collected from Hologic's Discovery™ Series and Explorer™ Technical Specifications Manual, December 2003 and GE Lunar's Safety Information and Technical Specifications, October 2008.
4. J Clin Densitom. 2013 Jan-Mar;16(1):75-8. doi: 10.1016/j.jocd.2012.09.002. Epub 2012 Nov 11.

© 2017 General Electric Company – All rights reserved.

GE Healthcare reserves the right to make changes in specifications and features shown herein, or discontinue the product described at any time without notice or obligation. Contact your GE Healthcare representative for the most current information. GE, the GE Monogram, CoreScan, SmartScan, Prodigy, and Trabecular Bone Score are trademarks of General Electric Company. GE Healthcare, a division of General Electric Company. GE Medical Systems, Inc., doing business as GE Healthcare. DICOM is a trademark of National Electrical Manufacturers Association. Windows is a registered trademark of Microsoft Corporation. All other third party trademarks are the property of their respective owners.



October 2017
JB52795US